

170150 FieldMonitor™ Internal 3300 NSv Proximator® Module

Bently Nevada™ Asset Condition Monitoring

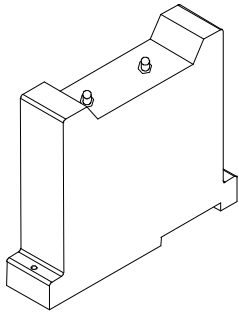

Description

Transducer System

The 170150 Internal 3300 NSv™ Proximity Transducer Module is intended for use with the 1701 FieldMonitor™ Monitoring System. Its primary intent is for monitoring radial vibration or axial (thrust) position on centrifugal air compressors, refrigeration compressors, small process gas compressors and other machines with tight installation requirements. The 170150 Internal 3300 NSv Proximity Transducer Module uses 3300 NSv or 3300 RAM probes and extension cables. This transducer is available only as a 7-metre system (system length includes the combined length of the probe and extension cable).

The primary uses for the 170150 Internal 3300 NSv Transducer Module are for areas in which either counterbore, sideview or rearview restrictions limit the use of Bently Nevada, LLC's standard 170133 Internal 3300 5 mm and 8 mm Proximity Transducer Module. The 170150 is also ideal for small target applications, such as measuring radial vibration on shafts smaller than 51 mm (2 in) or axial position on flat targets smaller than 15 mm (0.6 in).

Applications use the 1701 FieldMonitor Proximity Transducer Modules primarily when they integrate the vibration protection system with a machine control system that uses distributed I/O over appropriate networks. The module's design is for installation near to or on the machine skid. The 1701 FieldMonitor Monitoring System combines the Internal Proximator® Sensor with the monitoring system in a common housing, eliminating expensive field wiring between the two components. The thin mounting package allows you to combine numerous Proximator modules and monitor modules in a single housing. Specific advantages of the modules over vibration transmitters include providing vibration and gap values, diagnostic OK checking, field programmability of ranges and other parameters, and connectivity to Bently Nevada™ machinery management software using the 1701/22 FieldMonitor Management Interface Module (FMIM).

Each 170150 Internal 3300 NSv Proximity Transducer Module has 2 separate channels for inputs from 2 separate 3300 NSv or 3300 RAM probes and extension cables. The installation should use the Internal Transducer Module, rather than a separate 3300 NSv Proximator Sensor or 3300 RAM Proximator Sensor, if the probe tip is less than 7 metres from the 1701 FieldMonitor Monitoring System. The 170150 Module has a scale factor output of 200 mV/mil, which is the most common output for eddy current transducers. The enhanced side-view and small target viewing characteristics of the probe gives the 170150 Module a shorter linear range (1.5 mm [60 mils]) than our 170133 Internal 3300 5 mm and 8 mm Proximity Transducer Module.

Notes: The factory supplies 1701 Internal NSv Proximity Transducer Modules that are calibrated by default to AISI 4140 steel. Modules that are calibrated to other target materials are available upon request.



Specifications

Unless otherwise noted, the following specifications are for a 3300 XL NSv Proximitor Sensor, extension cable and probe between 0 °C and +45 °C (+32 °F to +113 °F), with a -24 Vdc power supply, a 10 kΩ load, a Bently Nevada, LLC supplied AISI 4140 steel target that is 31 mm (1.2 in) diameter or larger, and a probe gap of 1.0 mm (40 mils). The system accuracy and interchangeability specifications do not apply for installations that use a transducer system calibrated to any target other than a AISI 4140 steel target supplied by Bently Nevada, LLC.

Note: Operation outside the specified limits may result in false readings and/or loss of machine monitoring.

Electrical

Proximitor Sensor Input

Accepts one non-contacting 3300 RAM or 3300 NSv Proximity Probe and Extension Cable.

Probe dc Resistance

See Table 1.

Table 1: R_{PROBE} for Various Probe Lengths

Probe Length (m)	Resistance from the Center Conductor to the Outer Conductor (R _{PROBE}) (ohms)
0.5	4.0 ± 0.5
1.0	4.2 ± 0.5
7.0	5.9 ± 0.9

Extension cable dc resistance

Center conductor

0.220Ω/m (0.067 Ω/ft)

Shield

0.066 Ω/m (0.020 Ω/ft)

Linear Range

1.5 mm (60 mils). Linear range begins at approximately 0.25 mm

(10 mils) from target and is from 0.25 to 1.75 mm (10 to 70 mils) (approximately -1 to -13 Vdc).

Recommended Gap Setting

1.0 mm (40 mils)

System Performance

Incremental Scale Factor (ISF)

7.87 V/mm (200 mV/mil) +14%/-21.5% including interchangeability error when measured in increments of 0.25 mm (10 mils) over the 1.5 mm (60 mil) linear range.

Deviation from best fit straight line (DSL)

Less than ±0.06 mm (±2.3 mils).

Frequency Response:

0 to 15 kHz: +0, -3 dB typical, at 1.0 mm (40 mil) probe gap.

Target Size (flat target):

Minimum

8.9 mm (0.35 in) diameter

Recommended minimum

13 mm (0.5 in) diameter

Note: Axial position measurements on shaft diameters smaller than 13mm (0.5 in) will generally change the scale factor. Reducing the gap between the probe and target will help limit this change. See Figure 7 for additional information.

Shaft Diameter

Minimum (standard X-Y probe configuration)

30 mm (1.2 in)

Minimum (X-Y proximity probes offset axially by 23 mm (0.9 in)):

20 mm (0.8 in)

Note: Measurements on shaft diameters smaller than 30 mm (1.2 in) usually require close spacing of radial vibration or axial position transducers. This can cause their electromagnetic emitted fields to interact with one another (create cross-talk), resulting in erroneous readings. To prevent cross-talk, maintain minimum separation of transducer tips of at least 25 mm (1.0 in) for axial position measurements or 23 mm (0.9 in) for radial vibration measurements (see Figure 9 and Figure 10 for additional information.) Radial vibration or radial position measurements on shaft diameters smaller than 20 mm (0.8 in) will generally change the Average Scale Factor by more than 10%. See Figure 8 for additional information.

Counterbore

Minimum: 9.5 mm (0.375 in)

Recommended minimum: 13 mm (0.5 in)

Note: Counterbores smaller than 13 mm (0.5 in) generally change the scale factor at far gaps. Reducing the gap between the probe and the target will allow the transducer system to maintain its Average Scale Factor (ASF) over a reduced linear range. See Figure 4 for additional information.

Effects of 60 Hz Magnetic Fields Up to 300 Gauss:

See Table 2.

Table 2: Output Voltage in Mills pk-pk / Gauss

Gap in mm (mils)	Proximator Sensor	Probe	Ext. Cable
0.25 (10)	0.028	0.002	0.001
1.0 (40)	0.029	0.003	0.002
1.75 (70)	0.035	0.004	0.005

Hazardous Area Approvals

-00 Approvals Ordering Option

North America

Ex nA IIC T4
 Class I, Zone 2
 Class I, Div 2
 Groups A, B, C, D
 T4 @ -30°C = Ta = +70°C
 per dwg 139255

Certification Number

CSA 1166985

European/ATEX

 II 3G EEx nA [L] IIC T4
 LCIE 00ATEX6016X
 T4 @ -30°C = Ta = +70°C

Brazil

Br-Ex nA [nL] IIC T4
 MC, AEX-8304-X
 T4 @ -30°C = Ta = +70°C

-05 Approvals Ordering Option

North America

Ex nA [ia] IIC T4
 Class I, Zone 2(0)
 Class I, Div 2
 Groups A, B, C, D
 T4 @ -30°C = Ta = +70°C
 per dwg 141265

Certification Number

CSA 1166985

European/ATEX

 II 1/3 G EEx nA[ia] ia IIC T4
 LCIE 00ATEX6017X
 T4 @ -30°C = Ta = +70°C

Mechanical**Probe Tip Material**

Polyphenylene sulfide (PPS).

Probe Case Material

AISI 304 stainless steel (SST).

Probe Cable Specifications

75 Ω coaxial, fluoroethylene propylene (FEP) insulated probe cable in the following total probe lengths: 0.5, 1, or 7 metres (1.6, 3.3, or 23.0 feet).

Extension Cable Material

75 Ω coaxial, fluoroethylene propylene (FEP) insulated.

Proximator Sensor Material

Aluminum (epoxy powder coated finish)

System Length

7 metres (23.0 feet) including extension cable

Extension Cable Armor (optional)

Flexible AISI 302 SST with or without FEP outer jacket.

Tensile Strength (maximum rated)

220 N (50 lbf) probe case to probe lead.

220 N (50 lbf) at probe lead to extension cable connectors.

220 N (50 lbf) probe case to stainless steel armor.

Connector material

Gold-plated brass

Probe Case Torque

See Table 3.

Table 3: Probe Case Torque Values

Probe case torque:	Maximum Rated	Recommended
1/4-28 or M8x1 probe cases	7.3 N•m (65 in•lb)	5.1 N•m (45 in•lb)
3/8-24 or M10x1 probe cases	33.9 N•m (300 in•lb)	11.3 N•m (100 in•lb)
3/8-24 or M10x1 probe cases – first three threads	22.6 N•m (200 in•lb)	7.5 N•m (66 in•lb)
Reverse mount probes	22.6 N•m (200 in•lb)	7.5 N•m (66 in•lb)

Connector-to-connector torque**Recommended torque**

See Table 4.

Table 4: Recommended Connector-to-Connector Torque

Connector Type	Tightening Instructions
Two 3300 XL gold "click" type connectors	Finger tight
One non-XL stainless steel connector and one 3300 XL connector	Finger tight plus 1/8 turn using pliers

Maximum torque

0.56 N•m (5 in•lbf)

Minimum Bend Radius (with or without sst armor)

25.4 mm (1.0 in)

System Weight (typical)**Probe:**

Approximately 14 to 150 g (0.5 to 5.3 oz)

Extension Cable

45 g/m (0.5 oz/ft)

Armored**Extension Cable**

64 g/m (0.7 oz/ft)

170150**Proximator****Module**

353 g (12.5 oz)

Environmental Limits**Probe****Temperature****Range****Operating****Temperature**

-34 °C to +177 °C (-30 °F to +351 °F)

Storage**Temperature**

-51 °C to +177 °C (-60 °F to +351 °F)

Note: Exposing the probe to temperatures below -34 °C (-30 °F) for a sustained period of time may cause premature failure of the pressure seal.

Extension Cable**Temperature****Range****Operating and****Storage****Temperature**

-51 °C to +177 °C (-60 °F to +351 °F)

Proximator**Sensor****Temperature****Range****Operating****Temperature**

-35 °C to +85 °C (-31 °F to +185 °F)

Storage**Temperature:**

-40 °C to +85 °C (-40 °F to +185 °F)

Relative**Humidity:**100% condensing, non-submersible
from +7 °C to +85 °C (+45 °F to

+185 °F) with less than 3% change in Average Scale Factor (ASF) when connectors are protected.

Probe Pressure:

3300 NSv probes are designed to seal differential pressure between the probe tip and case. The probe sealing material consists of a Viton® O-ring. We do not pressure test probes prior to shipment.

Contact our custom design department if you require a test of the pressure seal for your application

Note: It is the responsibility of the customer or user to ensure that all liquids and gases are contained and safely controlled should leakage occur from a proximity probe. In addition, solutions with high or low pH values may erode the tip assembly of the probe causing media leakage into surrounding areas. Bently Nevada, LLC will not be held responsible for any damages resulting from leaking 3300 NSv Proximity Probes. In addition, 3300 NSv Proximity Probes will not be replaced under the service plan due to probe leakage.

Patents:

Components or procedures in one of more for the following patents apply to this product: 5,016,343; 5,126,664; 5,351,388; and 5,685,884.

Ordering Information**170150 FieldMonitor Internal 3300 NSv Dual Proximator Module****170150-AXXX-BXX****A:** Total Length and Mounting Option**070** 7.0 metres (23.0 feet) system length**B:** Agency Approval Option**Note:** Use the **05** option in the 1701/06 Isolator Terminal Base**00** Division 2/Zone 2**05** Division 2/Zone 2 for Monitor
Division 1, Zone 0/1 for Transducers

3300 NSv Proximity Probes:

- 330901 3300 NSv Probe, 1/4-28 UNF thread, without armor
- 330902 3300 NSv Probe, 1/4-28 UNF thread, with armor
- 330908 3300 NSv Probe, 3/8-24 UNF thread, without armor
- 330909 3300 NSv Probe, 3/8-24 UNF thread, with armor
Part Number-AXX-BXX-CXX-DXX-EXX

A: Unthreaded Length Option

Note: Unthreaded length must be at least 0.7 inch less than the case length.

Order in increments of 0.1 in

Length configurations:

Maximum unthreaded length: 9.2 in

Minimum unthreaded length: 0.0 in

Example: 0 4 = 0.4 in

B: Overall Case Length Option

Order in increments of 0.1 in

Threaded length configurations:

Maximum case length: 9.9 in

Minimum case length: 0.8 in

Example: 2 4 = 2.4 in

C: Total Length Option

0 5 0.5 metre (20 in)

1 0 1.0 metre (39 in)

7 0 7.0 metres (23.0 feet)

D: Connector and Cable-Type Option

0 1 Miniature coaxial ClickLoc™ connector with connector protector, standard cable

0 2 Miniature coaxial ClickLoc connector, standard cable

1 1 Miniature coaxial ClickLoc connector with connector protector, FluidLoc® cable

1 2 Miniature coaxial ClickLoc connector, FluidLoc cable

E: Agency Approval Option

0 0 Not required

0 5 Multiple Approvals

3300 NSv Proximity Probes, Metric:

- 330903 3300 NSv Probe, M8 x 1 thread, without armor
- 330904 3300 NSv Probe, M8 x 1 thread, with armor
- 330905 3300 NSv Probe, M10 x 1 thread, without armor
- 330910 3300 NSv Probe, M10 x 1 thread, with armor
Part Number-AXX-BXX-CXX-DXX-EXX

A: Unthreaded Length Option

Note: Unthreaded length must be at least 20 mm less than the case length.

Order in increments of 10 mm.

Length configuration:

Maximum unthreaded length: 230 mm

Minimum unthreaded length: 0 mm

Example: 0 6 = 60 mm

B: Overall Case Length Option

Order in increments of 10 mm.

Metric thread configurations:

Maximum length: 250 mm

Minimum length: 20 mm

Example: 0 6 = 60 mm

C: Total Length Option

0 5 0.5 metre (20 in)

1 0 1.0 metre (39 in)

7 0 7.0 metres (23.0 feet)

D: Connector and Cable-Type Option

0 1 Miniature coaxial ClickLoc connector with connector protector, standard cable

0 2 Miniature coaxial ClickLoc connector, standard cable

1 1 Miniature coaxial ClickLoc connector with connector protector, FluidLoc cable

1 2 Miniature coaxial ClickLoc connector, FluidLoc cable

E: Agency Approval Option

0 0 Not required

0 5 Multiple Approvals

3300 NSv Reverse Mount Probe

330906-02-12- CXX-DXX-EXX, 3/8-24 UNF threads

330907-05-30- CXX-DXX-EXX, M10 x 1 threads

C: Total Length Option

0 5 0.5 metre (20 in)

1 0 1.0 metre (39 in)

7 0 7.0 metres (23.0 feet)

- D: Connector Option
- 0 2 Miniature coaxial ClickLoc connector, standard cable
 - 1 2 Miniature coaxial ClickLoc connector, FluidLoc cable

- E: Agency Approval Option
- 0 0 Not required
 - 0 5 Multiple Approvals
- 136536-01**

Note: For a shorter delivery time, order commonly stocked probes. Currently, stocked probes consist of the following part numbers:

330901-00-24-05-02-00, 330901-00-90-05-02-00,
 330902-00-50-05-02-00, 330902-00-95-05-02-00,
 330903-00-02-10-02-00, 330903-00-03-10-02-00, and
 330906-02-12-05-02-00.

40180-03

3300 NSv Extension Cable

330930-AXXX-BXX-CXX

Note: Make sure that the extension cable length and the probe length, when added together, equal the Proximitor sensor total length.

- A: Cable Length Option
- 0 6 0 6.0 metres (19.7 feet)
 - 0 6 5 6.5 metres (21.3 feet)
- B: Connector and Cable Option
- 0 0 Without stainless steel armor
 - 0 1 With stainless steel armor, with FEP jacket
 - 0 2 With stainless steel armor, without FEP jacket
 - 0 3 Without stainless steel armor, with connector protectors
 - 0 4 With stainless steel armor, with FEP jacket, with connector protectors
 - 0 5 With stainless steel armor, without FEP jacket, with connector protectors

03800000

03800001

- C: Agency Approval Option
- 0 0 Not required
 - 0 5 Multiple Approvals
- 330153-05**

163356

Accessories

139256-01

1701 FieldMonitor System Manual.

40113-03

Connector Protector Kit.

Connector Protector Kit for 3300 NSv probes and extension cables, including connector protectors and installation tools.

Connector Protector Adapter.

Allows connector protector installation tools manufactured prior to 1998 to be used with 75 Ω ClickLoc connectors.

Connector Protectors. Package contains 10 pairs of connector protectors for 75 Ω coaxial cable.

Male Connector Protector. Placed on the extension cable to connect to the female connector protector on the probe and provide environmental protection of connectors.

Female Connector Protector.

Placed on the probe lead to connect to the male connector protector on the extension cable and provide environmental protection of connectors.

3300 NSv Connector Kit. Used on 3300 NSv probes and extension cables. Contains one set of male and female ClickLoc connectors, sleeves and one strip of silicone tape.

Connector Crimp Tool Kit.

Includes one set of 75 Ω ClickLoc inserts and connector installation instructions. Supplied with carrying case.

Graphs and Figures

Note: All dimensions shown are in millimetres (inches) unless noted otherwise.

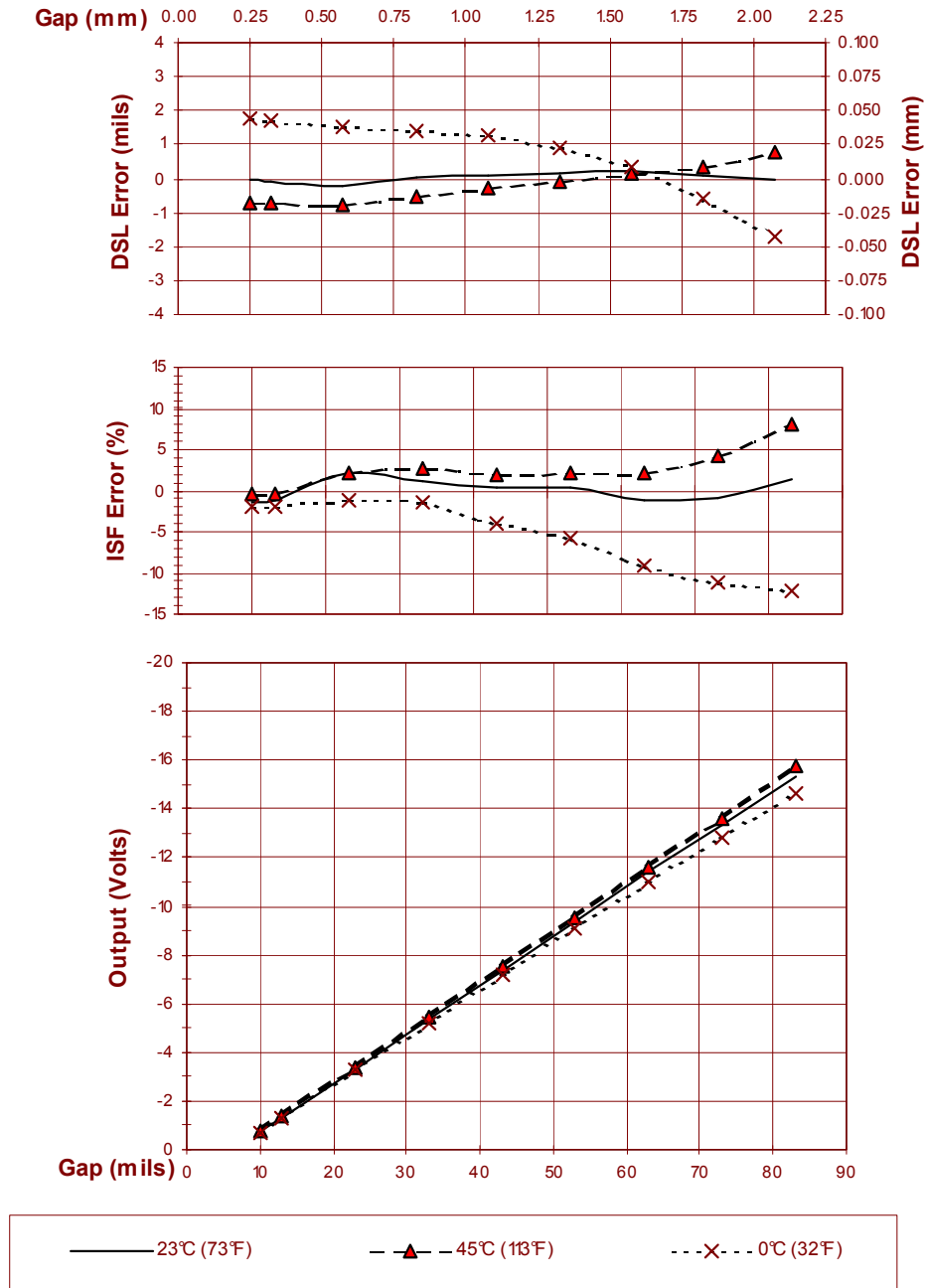

Figure 1: Typical 170150 Internal 3300 NSv™ Proximity Transducer Module Over Ambient Temperature Range

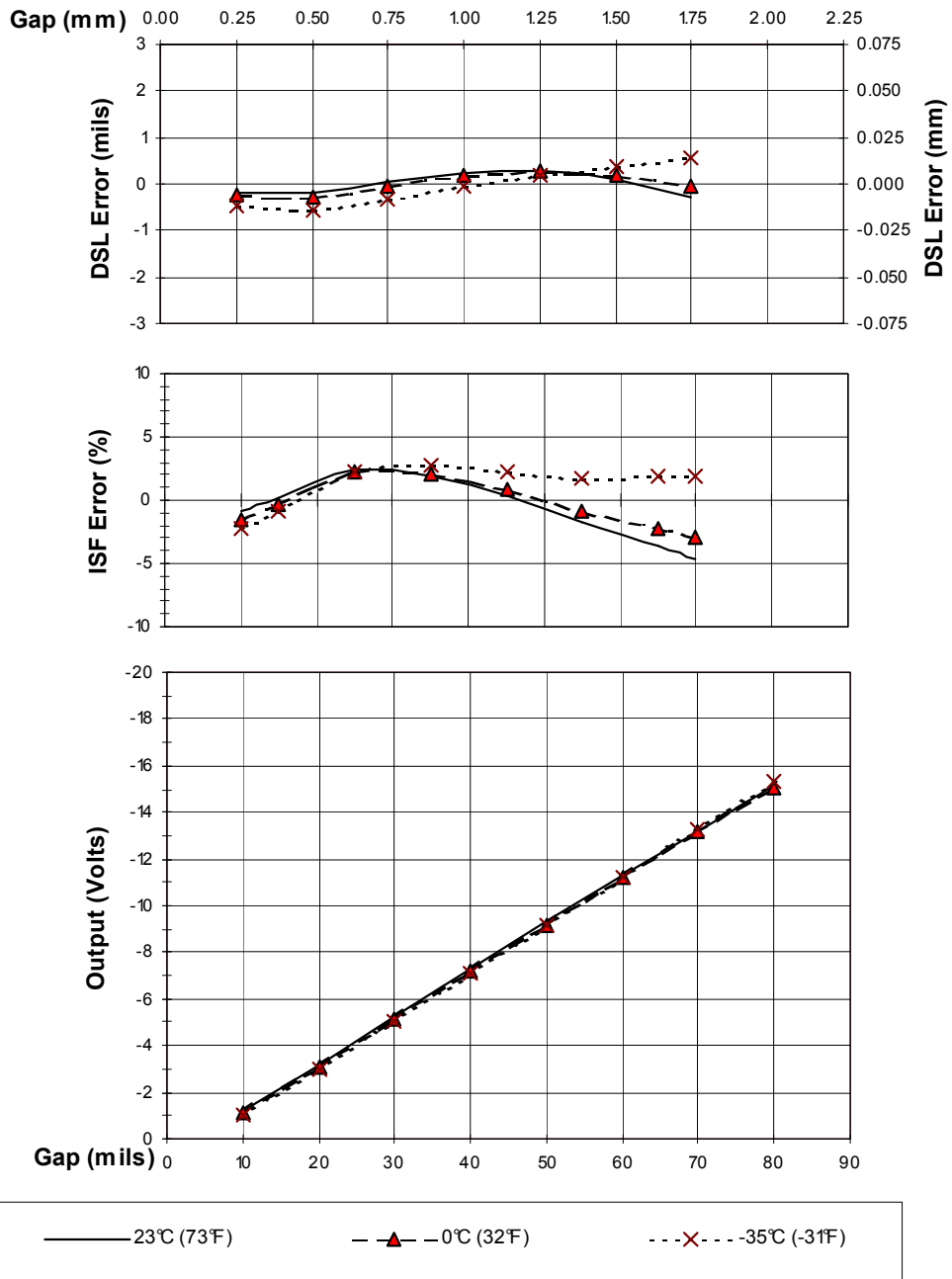

Figure 2: Typical 170150 Internal 3300 NSv™ Proximity Transducer Module with 6 m of Extension Cable @ Low Temperature (Probe is at 25°C)

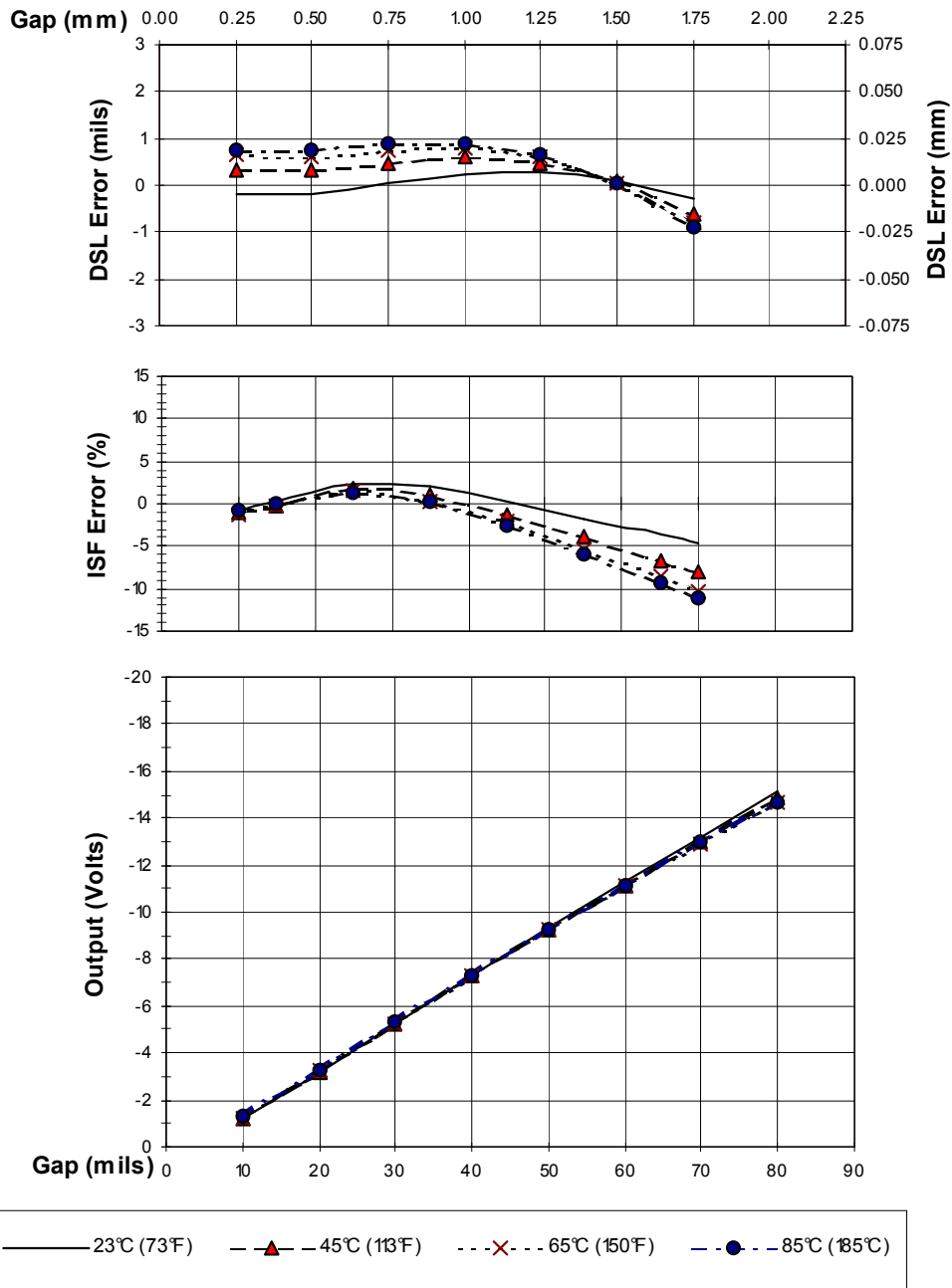

Figure 3: Typical 170150 Internal 3300 NSv™ Proximity Transducer Module with 6 m Extension Cable @ High Temperature (Probe is at 25°C)

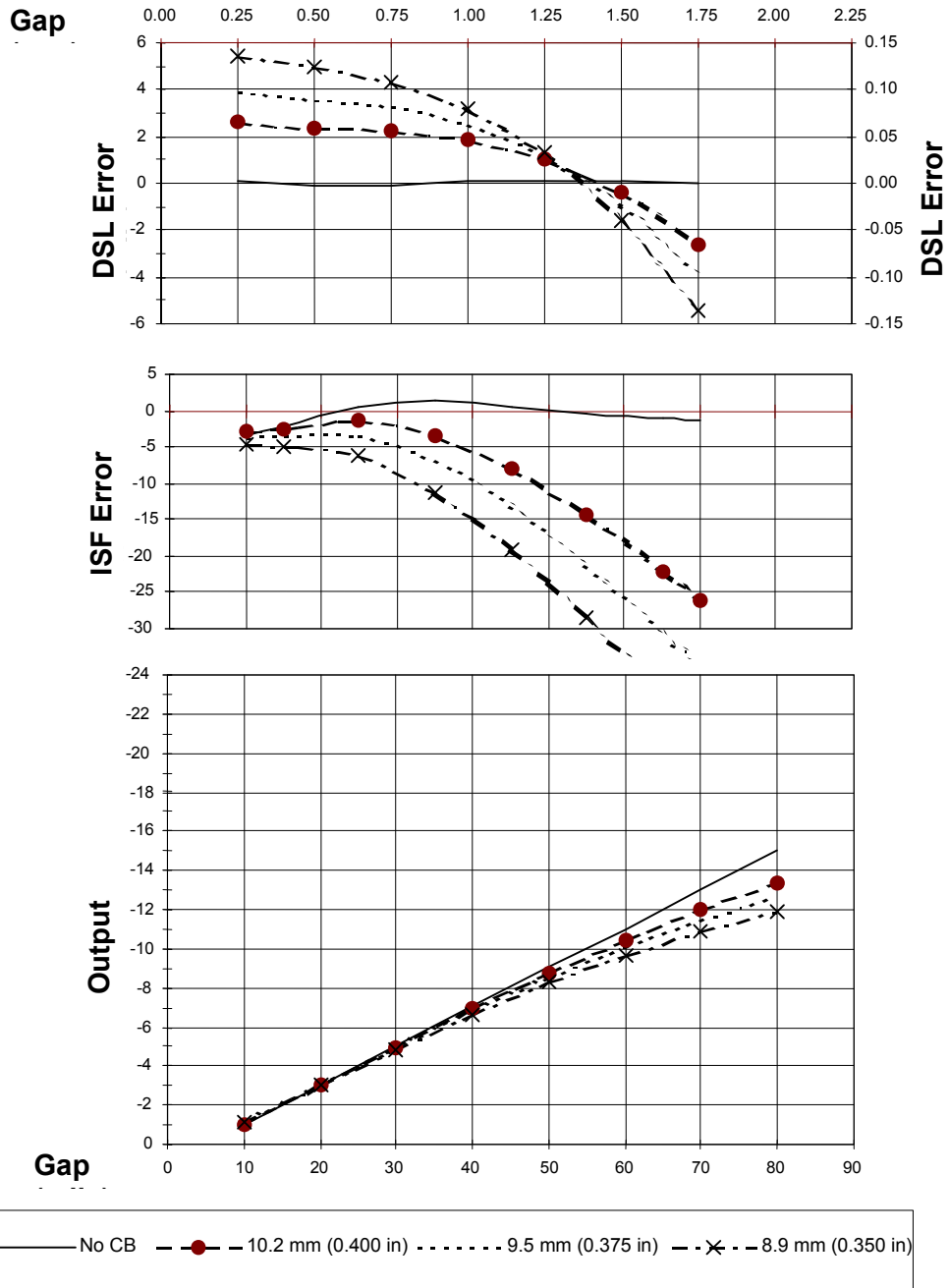

Figure 4: Effect of Counterbore Side Clearance (4140 Material)

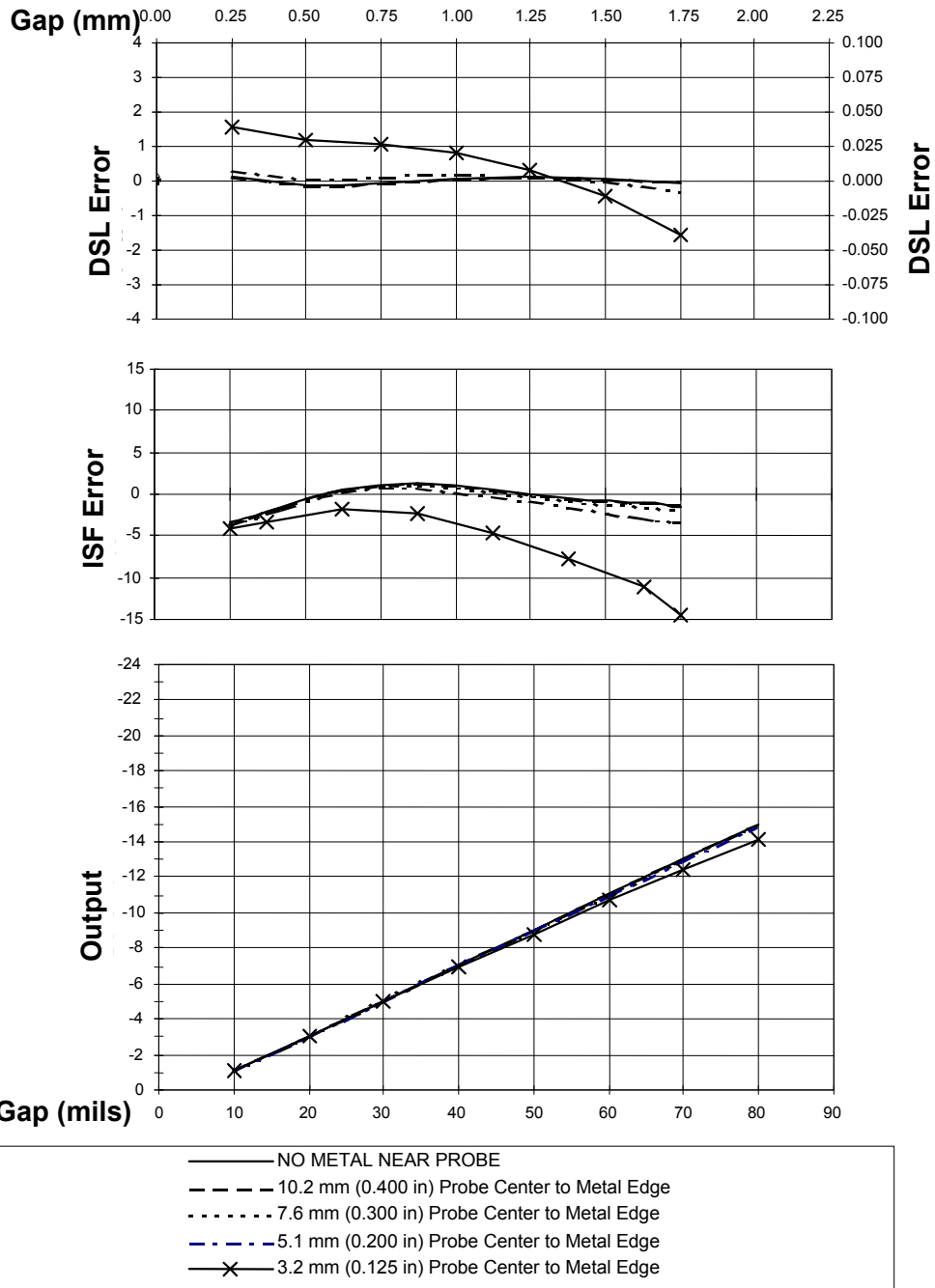

Figure 5: Effect of Flat Surface Side Clearance (4140 Material)

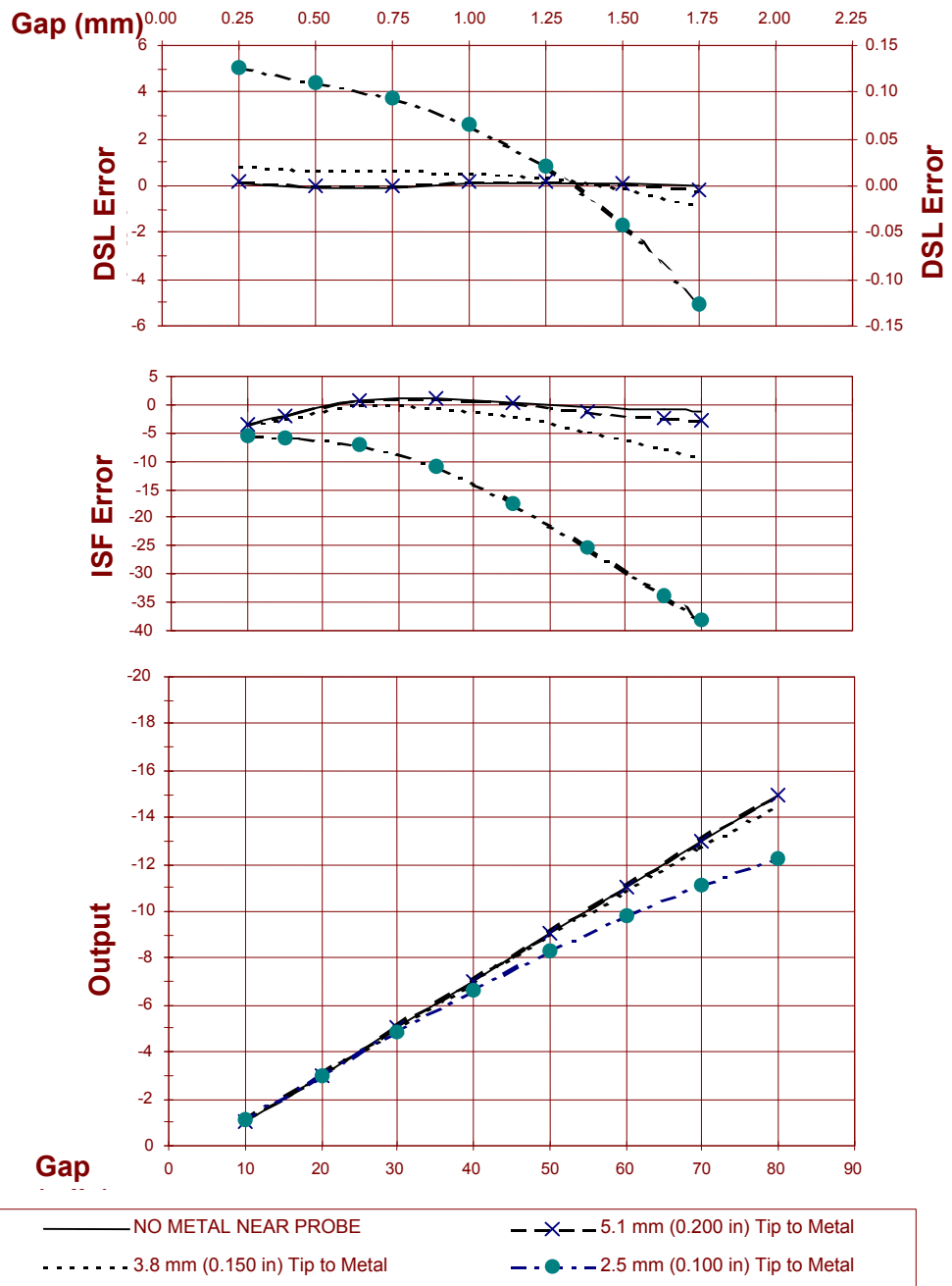

Figure 6: Effect of Rear Surface Clearance (4140 Material)

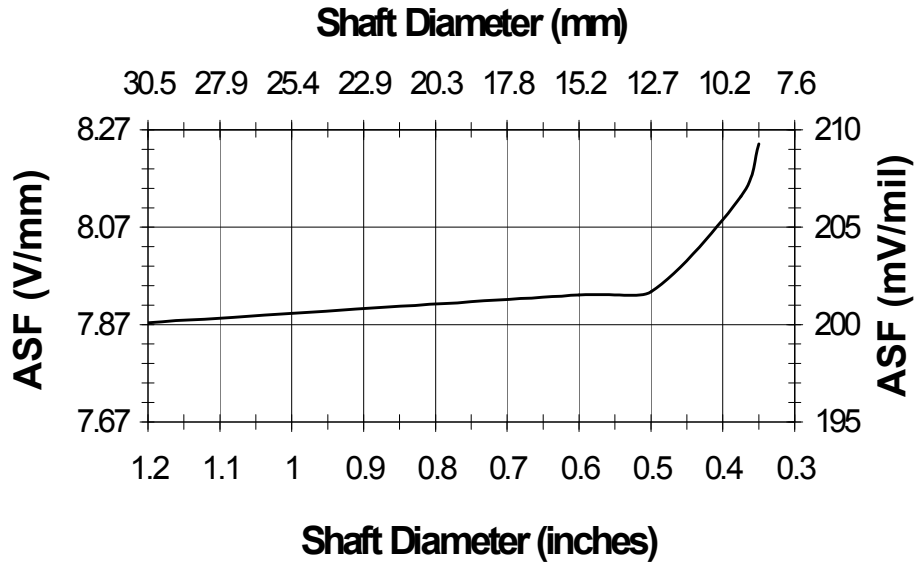

Figure 7: Axial Sensitivity to Shaft Size

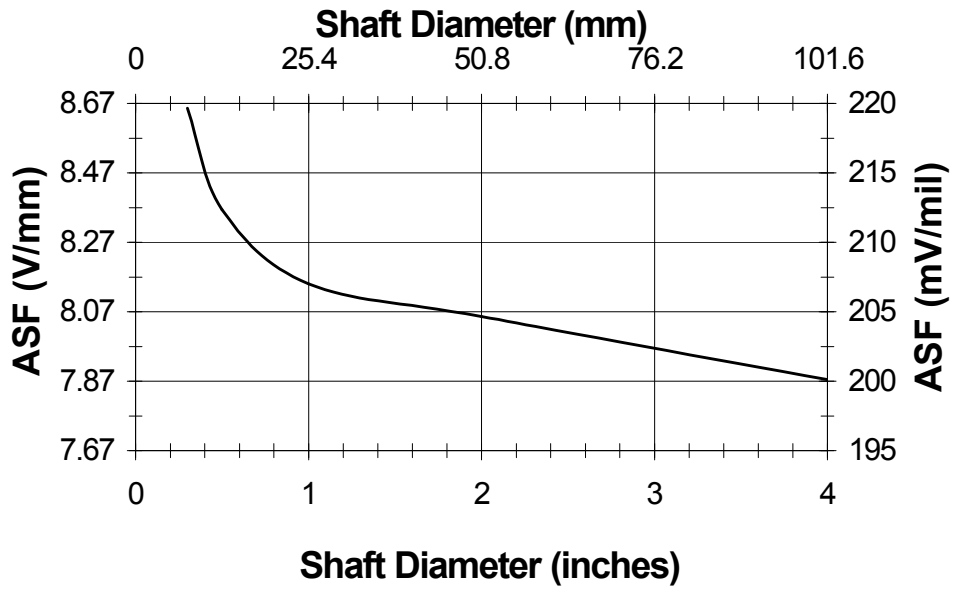

Figure 8: Radial Sensitivity to Shaft Size

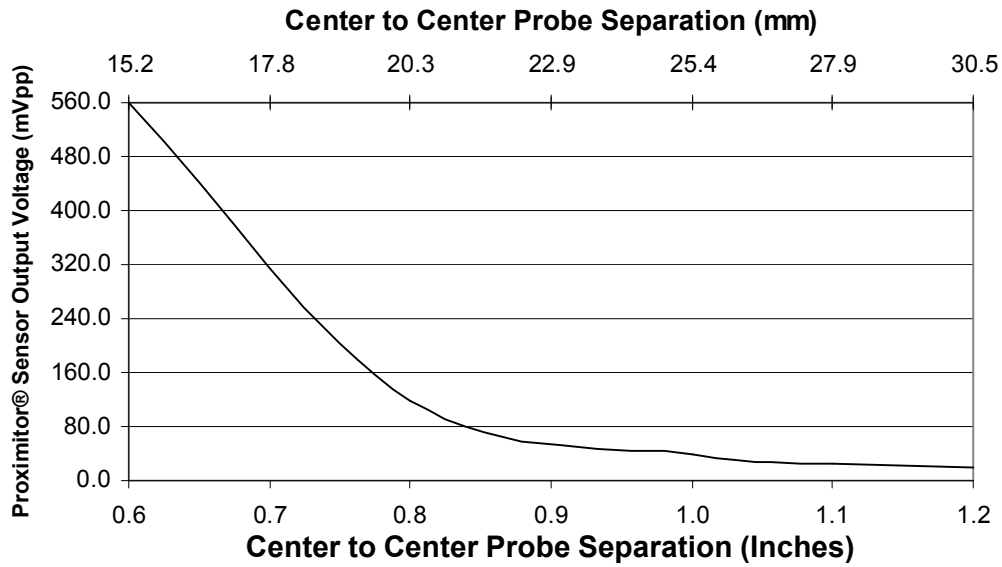

Figure 9: Probe Cross-talk with Probes Mounted in Parallel

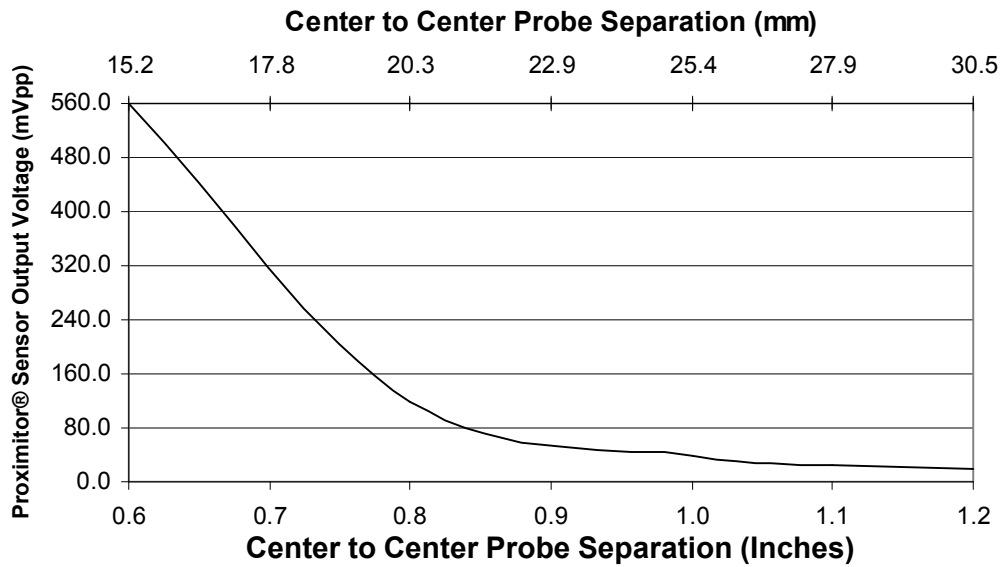

Figure 10: Probe Cross-talk with Probes Mounted in X-Y Configuration

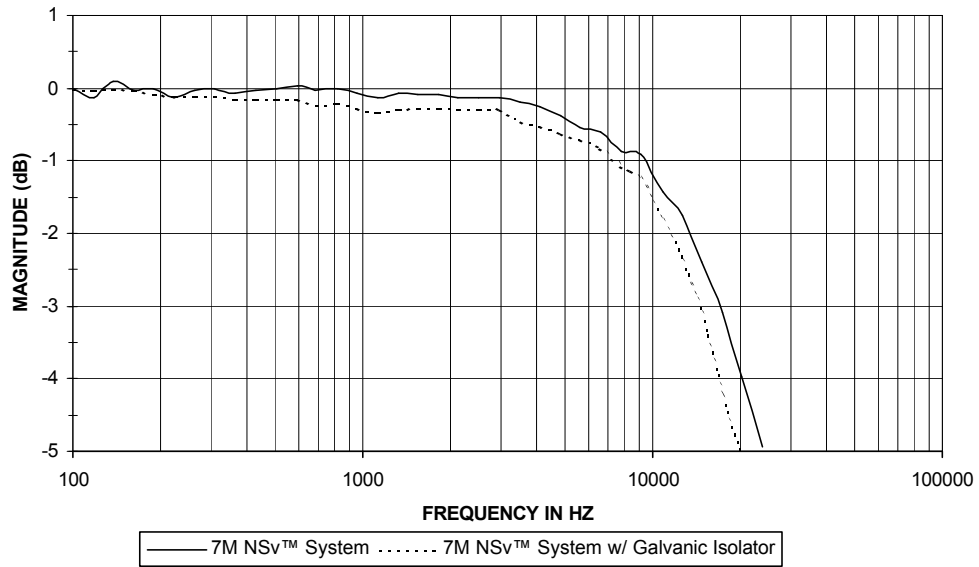

Figure 11: Frequency Response, magnitude of typical 170150 Internal 3300 NSv™ Proximity Transducer Module

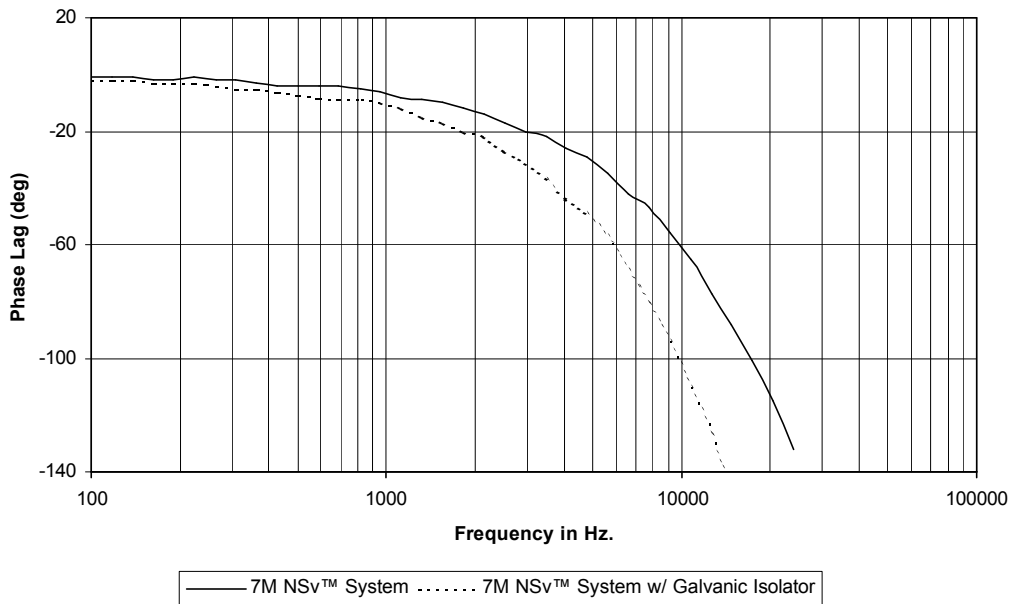

Figure 12: Frequency Response, phase change of typical 170150 Internal 3300 NSv™ Proximity Transducer Module

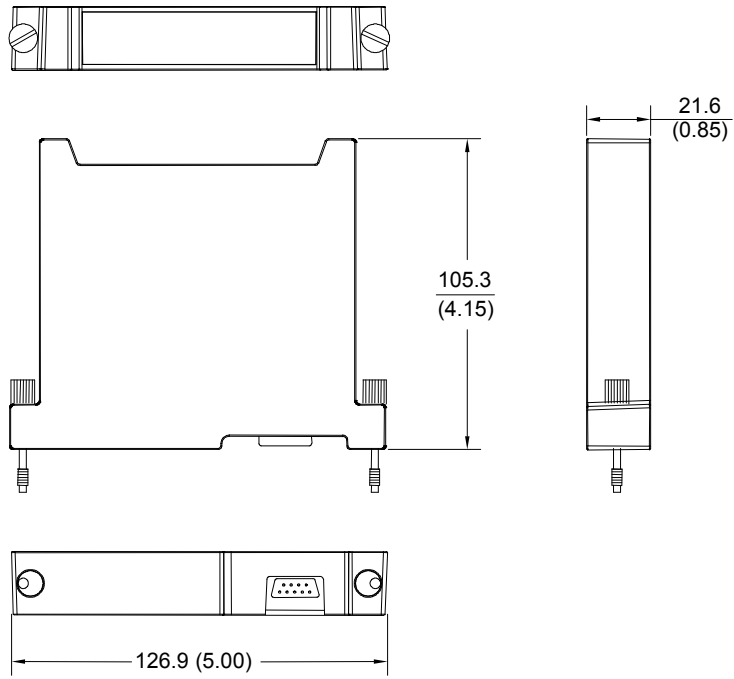
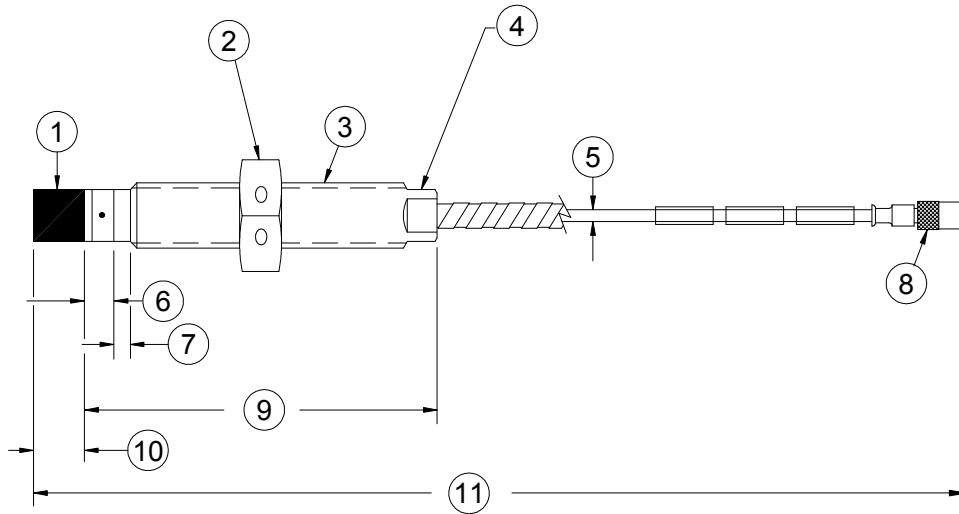

Figure 13: 170150 Internal 3300 NSv™ Proximity Transducer Module



1. Probe tip, 5.26 mm (0.207 in) maximum diameter
2. Hexagonal nut
3. Case thread
4. Wrench flats
5. 750 cable, 2.8 mm (0.11 in) maximum outside diameter, 7.6 mm (0.30 in) maximum outside diameter of armor
6. 3.23 mm (0.127 in)
7. Unthreaded length "A"
8. Miniature male coaxial connector, 7.23 mm (0.285 in) maximum outside diameter "D"
9. Case length "B"
10. 2.92 mm (0.115 in) maximum
11. Total length "C", +30%, -0%

Figure 14: 3300 NSvä Proximity probes, Standard Mount

- 330901, ¼ -28 UNF-2A, without armor
- 330902, ¼ -28 UNF-2A, with armor
- 330903, M8x1 thread, without armor
- 330904, M8x1 thread, with armor
- 330905, M10x1 thread, without armor
- 330908, 3/8-24 UNF-2A, without armor
- 330909, 3/8-24 UNF 2A, with armor
- 330910, M10x1 thread, with armor

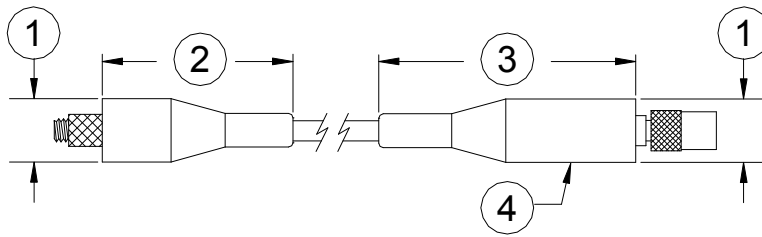

1. 12 mm (0.49 in) maximum outside diameter
2. 36.3 mm (1.43 in) maximum
3. 51.1 mm (2.01 in) maximum
4. Connector protector (fluorosilicone material)

Figure 15: Installed Connector Protectors

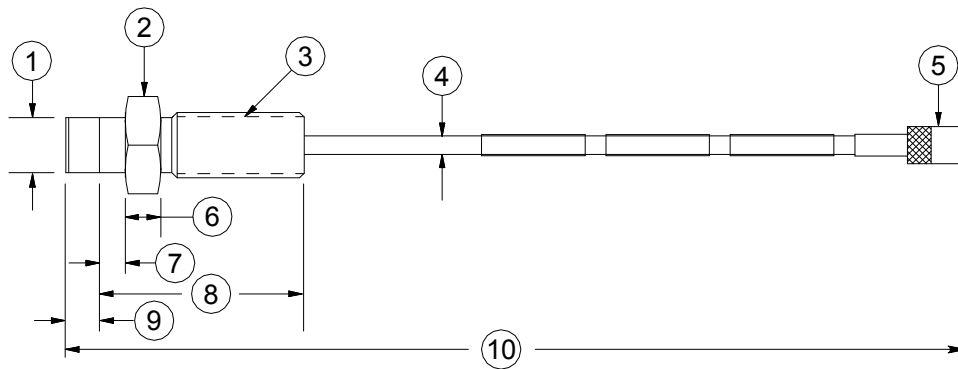

1. Probe tip, 5.26 mm (0.207 in) maximum diameter
2. 10 mm or 7/16 in hexagonal nut
3. Case Thread
4. 750 cable, 2.8 mm (0.11 in) outside diameter
5. Miniature male coaxial connector, 7.23 mm (0.285 in) maximum outside diameter "D"
6. 5.08 mm (0.20 in)
7. Unthreaded length "A", 5.08 mm (0.20 in)
8. Case length "B", 30.48 mm (1.20 in)
9. 2.92 mm (0.115 in) maximum
10. Total length "C", +3%, -0%

Figure 16 3300 NSvå Proximity Probes, Reverse Mount

330906, 3/8-24 UNF-2A threads

330907, M10x1 threads

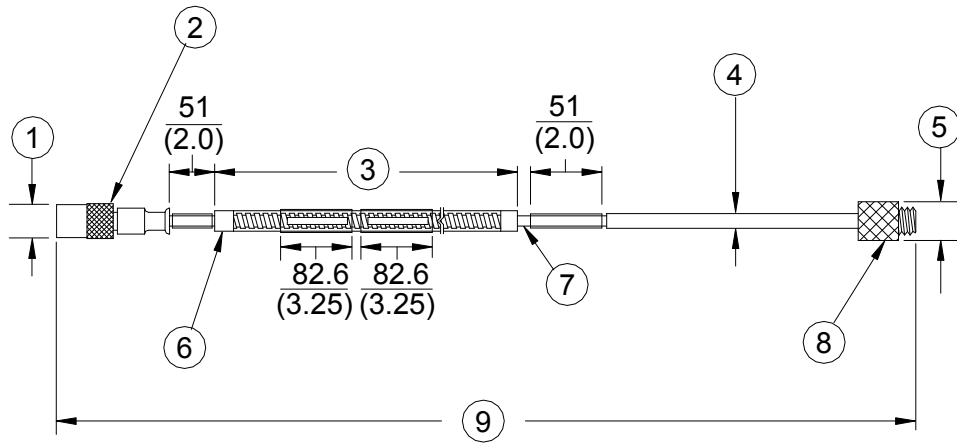

1. 7.2 mm (0.285 in) maximum diameter
2. Miniature male coaxial connector
3. FEP coated or uncoated armor. Armor length: 300 mm (11.8 in)
4. 750 cable, 2.80 mm (0.11 in) maximum outside diameter, 7.6 mm (0.30 in) maximum outside diameter of armor, 7.0 mm (0.275 in) maximum outside diameter of uncoated armor
5. 7.2 mm (0.285 in) maximum diameter
6. Stainless steel ferrules
7. FEP-insulated coaxial cable
8. Miniature femal coaxial connector
9. Cable length, +20%, -0%

Figure 17 330930, 3300 NSv Extension Cable

Notes:

1. Standard mount $\frac{1}{4}$ -28 UNF thread probes are supplied with $\frac{7}{16}$ inch lock nut and $\frac{7}{32}$ wrench flats.
2. Standard mount M8x1 thread probes are supplied with 13 mm lock nut and 7 mm wrench flats.
3. Standard mount $\frac{3}{8}$ -24 UNF thread probes are supplied with $\frac{9}{16}$ inch lock nut and $\frac{5}{16}$ wrench flats.
4. Standard mount M10x1 thread probes are supplied with 17 mm lock nut and 8 mm wrench flats.
5. Reverse mount probes are not available with armor or connector protector options.
6. Letters inside quotation marks on figures refer to probe ordering options.
7. Stainless steel armor is supplied with or without FEP outer jacket.
8. FEP jacket is standard on all non-armored probes.

Bently Nevada, NSv, FieldMonitor, Proximitytor, ClickLoc, and FluidLoc are trademarks of General Electric Company.
Viton is a trademark of DuPont Dow Elastomers L.L.C.

Copyright 2001 Bently Nevada LLC.
1631 Bently Parkway South, Minden, Nevada USA 89423
Phone: 775.782.3611 Fax: 775.215.2873
www.ge-energy.com/bently
All rights reserved.